

REVISION	DESCRIPTION	CHECK	APP	DATE	REV. NOTICE. NO
△1					
△2					
△3					

QFN36-0.5转接板连线图

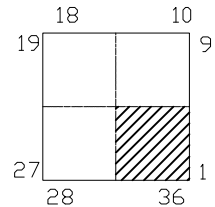

IC 脚位图

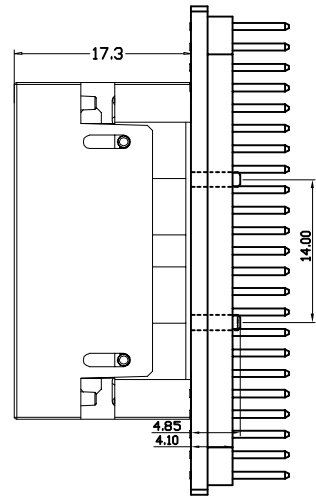
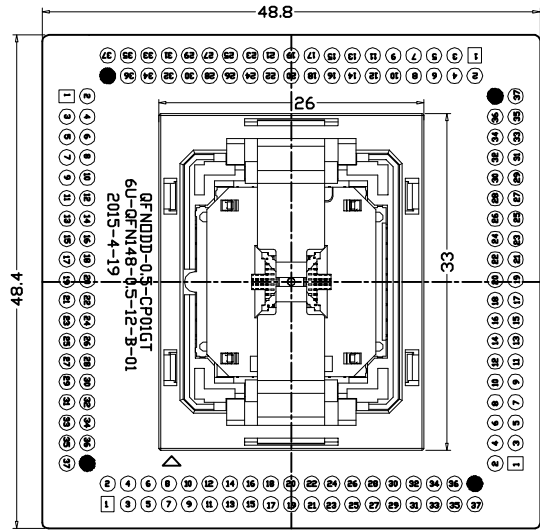
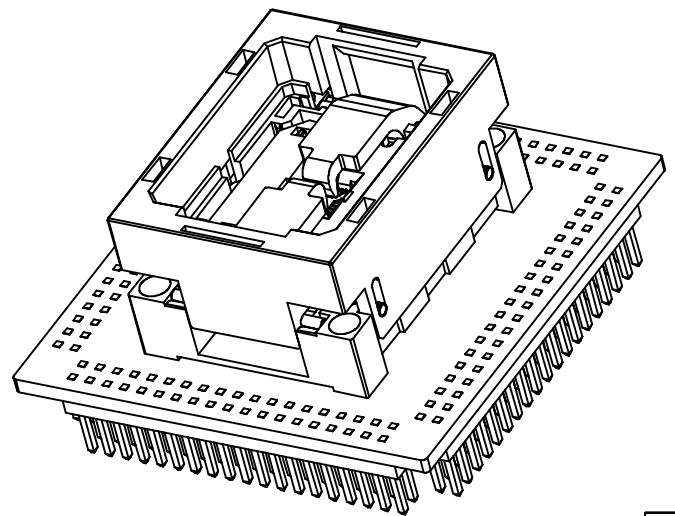
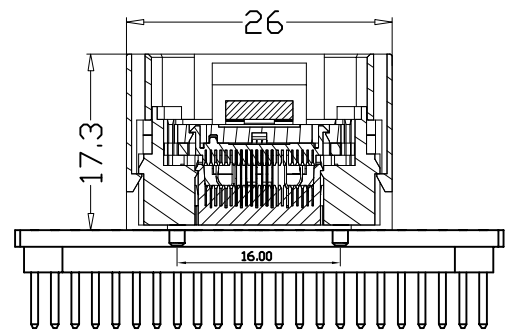
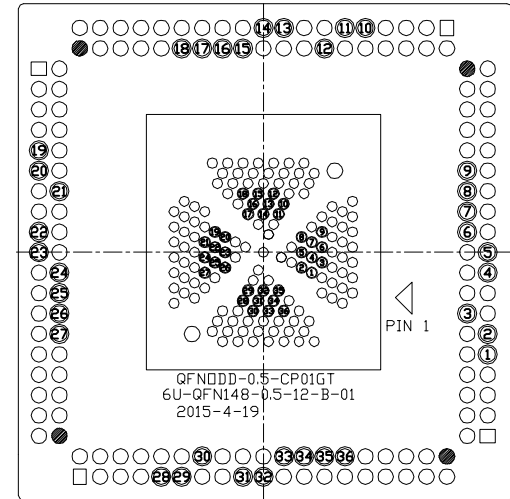

Applicable IC

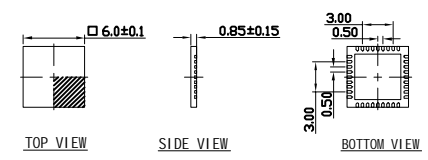

PROJECTION		GENERAL TOLERANCES	±0.10	TITLE	QFN36-0.5 SOCKET
		R E V	A	CLASS	QFN36-0.5-TP01G
DIMENSION:	mm	SCALE:	1:1	DRW. NO	QFN36-0.5-TP01G-A-01
APP:		DATE:			
CHECK:		DATE:			
DECK:		DATE:	20120822		